

# paper model No. 501h

Railway - Small diesel locomotive

Degree S4 – medium heavy

*Version 1.0*

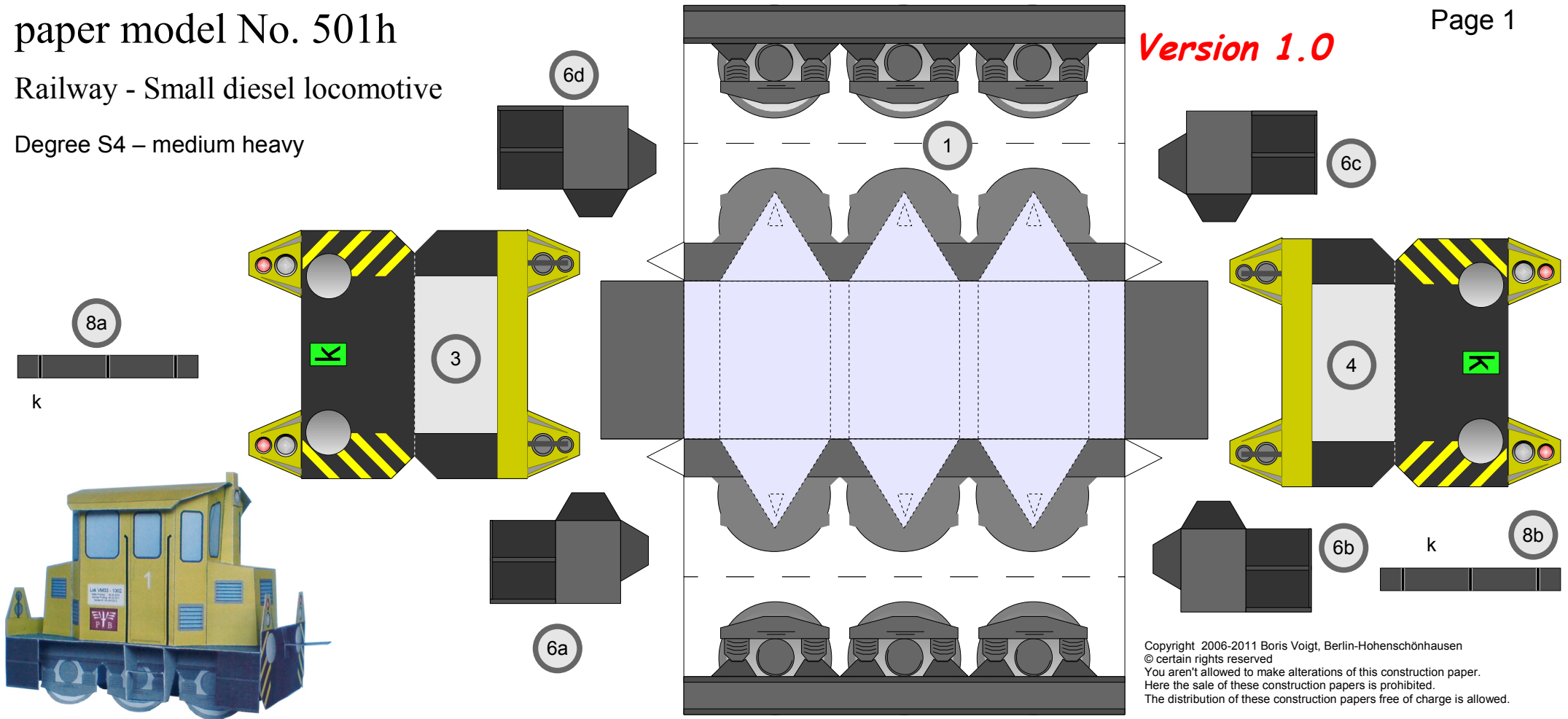

Copyright 2006-2011 Boris Voigt, Berlin-Hohenschönhausen  
© certain rights reserved  
You aren't allowed to make alterations of this construction paper.  
Here the sale of these construction papers is prohibited.  
The distribution of these construction papers free of charge is allowed.

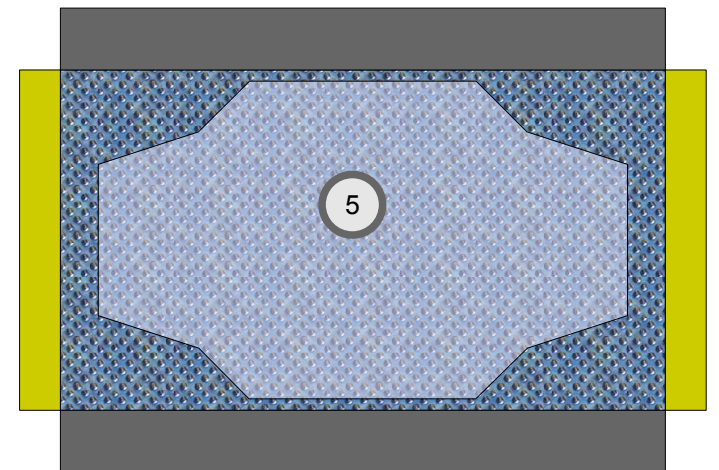
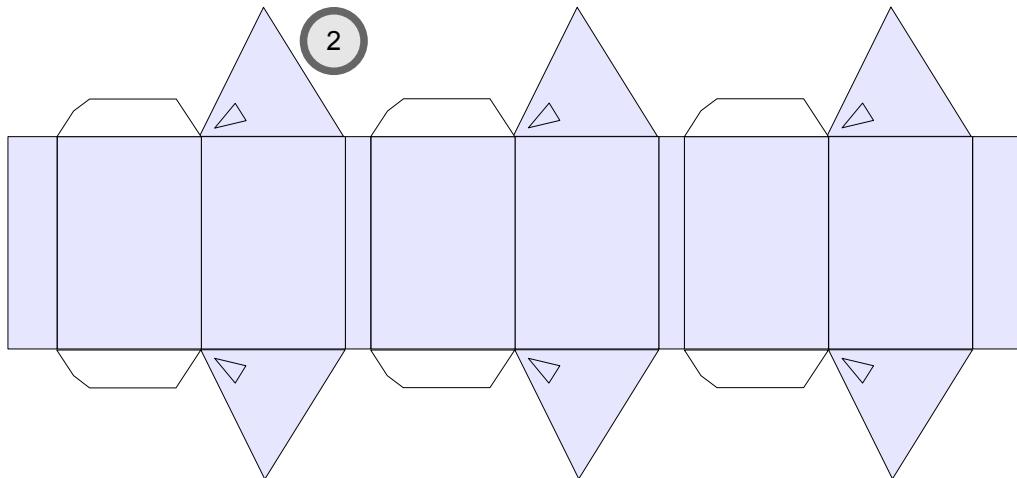

**Projekt Bastelbogen**  
www.projekt-bastelbogen.de

# paper model No. 501h

## Small diesel locomotive

Version 1.0

Page 2

12



11

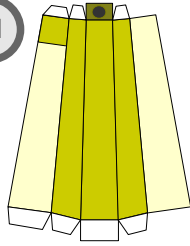

10

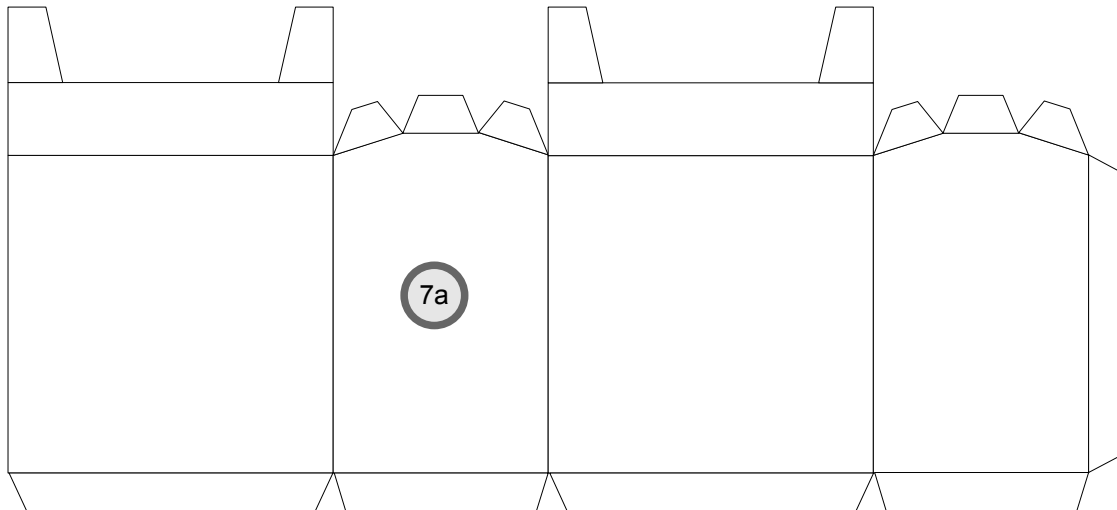
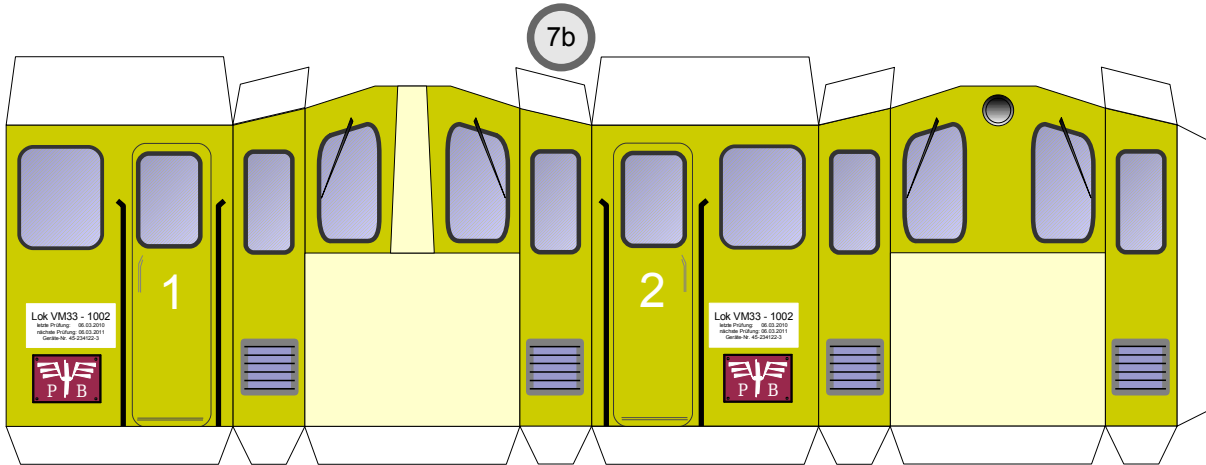
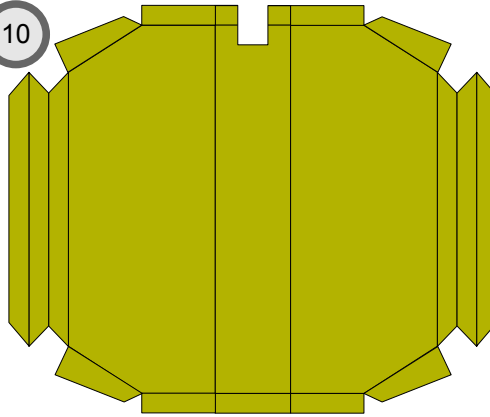

13a



13b

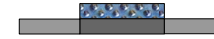

13c

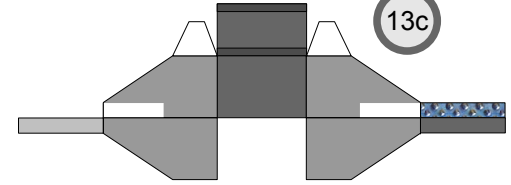

13d



Copyright 2006-2011 Boris Voigt, Berlin-Hohenschönhausen  
© certain rights reserved  
You aren't allowed to make alterations of this construction paper.  
Here the sale of these construction papers is prohibited.  
The distribution of these construction papers free of charge is allowed.

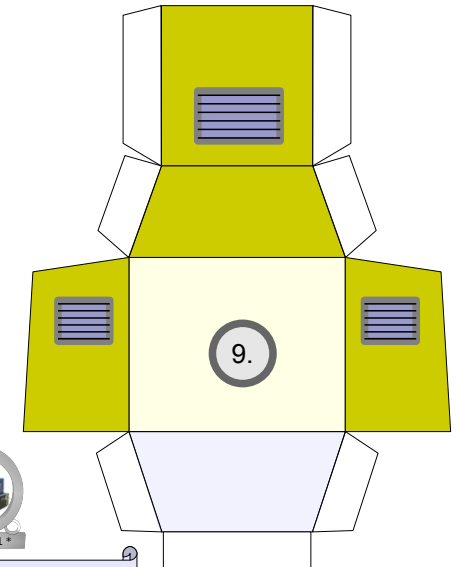
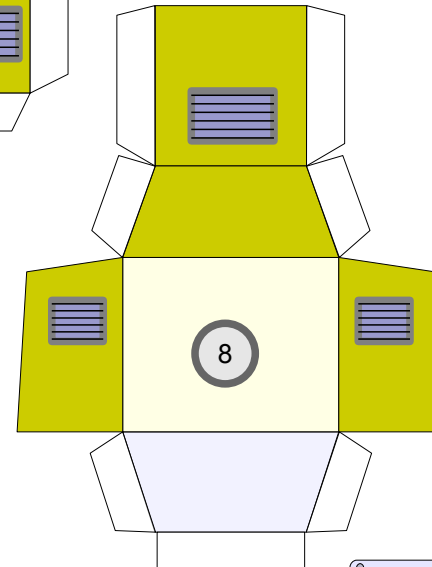

**Projekt Bastelbogen**  
www.projekt-bastelbogen.de